

**72R SERIES**

# Controls

Water & Air



## AIR SWITCHES AND CYLINDERS

### AIR SENSING SWITCHES

**72R0050**

RD-5-4475-0P

Normally Closed,  
Opens At 25 PSIG  
1/8"-27 NPTF Male



**72R0070**

RD-5-5538-0P

Normally Open,  
Closes at 21 TO 29 PSIG  
1/8" - 27 NPTF Male



### RED DOT AIR SWITCHES

**72R0100**

RD-5-4740-0P

Air Switch Guard



**72R0210**

RD-5-3827-1P

Black Toggle, Round



**72R0500**

RD-5-4747-0P

TOGGLE with guard used in fifth wheel slide and other pneumatic applications. Inlet & outlet are 1/8"-27 NPTF Female



**72R0190**

RD-5-5721-1P

Black Toggle  
With Quick Connect fittings  
1/4" in and 1/4" out



**72R0220**

RD-5-3827-2P

Nickle plated toggle



**72R0600**

RD-5-5721-0P

Black Toggle with Quick Connect fitting 1/4" In and 1/4" Out



**72R0200**

RD-5-3827-0P

Black Toggle, Flat



**72R0240**

RD-5-3827-4P

Chrome Push Button  
Momentary Off/Maintain On



**72R0610**

RD-5-4721-0P

Black Toggle with Quick Connect fitting 1/4" In and 1/8" Out



**72R0260**

RD-5-3827-6P



Black Toggle





AIR HOSE SHOWN IN SECTION 78  
Chrome mounting nut (1 1/2-32 UNF-2B)

**AIR CYLINDERS / HYDRAULIC CONTROL VALVES**

**SINGLE ACTION RED DOT AIR CYLINDERS**

Part No.	Factory No.	Cylinder Diameter	Cylinder Length	Stroke	Material	Mount	Air Fitting	
72R1100	RD-3267-1P	.75"	3.25"	1.02"	BRASS	D	A	
72R1200	RD-5-5414-4P	.625"	3.69"	1.10"	PLASTIC	F	B	
72R1210	RD-5-5784-5P	.625"	3.69"	1.10"	PLASTIC	F	C	

**DOUBLE ACTING RED DOT AIR CYLINDERS**

Part No.	Factory No.	Cylinder Diameter	Cylinder Length	Stroke	Material	Mount	Air Fitting	
72R1300	RD-5-5424-1P	.69"	4.74"	.5"	PLASTIC	F	B	
72R1310	RD-5-6028-1P	.79"	5.34"	.375"	PLASTIC	F	C	

- A 1/8" NPT Threads
- B 1/8" Nylon Hose Push-in Fitting
- C 3/8" Nylon Hose Push-in Fitting
- D 3/8"-18 UNF-2A Threaded Mounting
- F Plastic Mounting Plate

**SOLENOID VALVE**

Provides electric control for operation of air cylinders, air actuated shutters, air controlled clutching fans. Solenoid can be normally open or normally closed depending on control port used.  
1/8" - 27 NPT Threads

**72R1502** RD-5-0060-0P

12 VDC – Draws .65 AMPS



**72R1504** RD-5-0060-24P

24 VDC – Draws .45 AMPS



## AIR DIFFUSERS AND LOUVERS

**72R2000** RD-5-5476-0P

Snap In Louver Fits 1 3/8" X 5 3/4" Opening



**72R2100** RD-5-3709-0P

Louver Fits 1 3/4" X 3 5/8" Opening - Oval Connection



**72R2105** RD-5-6220-0P

Oval Connection All Black - 1 1/16" X 4 3/4" Opening



**72R2110** RD-5-6555-0P

Louver Fits 1.4" X 4.4" Opening



**72R2120** RD-3-8989-0P

Louver Fit 3" X 7 1/4" Opening



**72R2130** RD-5-5520-0P

Louver Fits 1.6" X 5.1" Opening - Stud Mount



**72R2140** RD-5-5552-0P

Louver Fits 1 3/4" X 5 1/8" Hole - Snap Mount



**72R2150** RD-5-4452-0P

Louver Fits 1 1/8" X 3 3/8" Opening - Snap Mount



**72R2160** RD-5-9637-0P

3 1/2" X 2 1/4" X 1 3/8" deep Opening - 3 1/4" X 1 1/16"  
Pivot: 1/4" diameter

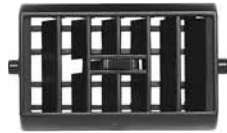

**72R2200** RD-5-4451-0P

Louver Fits 1 1/16" X 4 25/32" Opening - Stud Mount



**72R2250** RD-5-3597-0P

Fits 1 1/16" X 5 1/16" Opening - Clip Mount Louver\*  
Dimensions: 2 1/2" X 7 1/2" - 100% Shutoff



**72R2255** RD-5-10418-0P

Fits 2 1/2" X 7 1/2" Opening - Clip Mount Louver\*  
Outside dimension: 3" x 8"



**72R2300** RD-4340-0P

Louver Fits 2.69" X 6.50" Opening - Stud Mount



**72R2350** RD-5-10478-0P

Louver Fits 2 3/4" X 7 1/4" Opening - Snap Mount



**72R2351** RD-5-6987-0P

5 1/8" x 2" x 1" deep - Opening 4 3/4" x 2" x 1" deep



**72R2500** RD-5-3701-0P

Ball Louver With 2" Hose Adapter\* Fits 2 1/2" Hole



**72R2550** RD-5-3758-0P

Flush Mount Ball Louver\* †



**72R2600** RD-5-3702-0P

Ball Louver With 2 1/2" Hose Adapter\*



**72R2605** RD-5-10211-0P

Ball Louver With 2 1/2" Hose Adapter\*



**72R3000** RD-5-6017-0P

Fixed Vane 1 1/8" X 8 1/2"



**72R3010** RD-3-7838-2P

Right Hand Fixed Vane Defrost Outlet



**72R3020** RD-3-7838-3P

Left Hand Fixed Vane - Defrost Outlet



**72R3050** RD-5-3596-0P

2" Diffuser (Flush)



**72R3100** RD-5-5223-1P

3 1/2" Diffuser, 3 5/8" O.D., 3 1/16" mounting hole



\* 100% Shut Off

† Retaining Ring Sold Separately: RD 5-4611-0P



**AIR DIFFUSERS, LOUVERS, DUCTS AND ADAPTERS**

**72R3110** RD-5-5223-0P

3 1/2" Diffuser, 3 3/8" O.D., 3 3/16" mounting hole  
With Angled Base, includes spring



**72R3111** RD-5-5222-0P

3 3/4" x .907" Louver – 3 1/4" Opening



**72R3120** RD-5-8436-0P

3" Diffuser



**72R3130** RD-5-9024-0P

3" Diffuser



**72R3135** RD-5-10236-0P

3 1/2" Diffuser, 3 3/8" O.D., 3 1/4" mounting hole



**72R3140** RD-5-9053-0P

4" Diffuser



**72R3149** RD-5-11560-0P

Fits 3" Hole – 2" Hose



**72R3150** RD-5-9425-0P

Fits 3" Hole – 2 1/4" Hose 100% Shut Off – Inlet = 2.165"



**72R3151** RD-5-10030-0P

2" Hose



**72R3155** RD-5-9426-0P

Fits 3" Hole – 2 1/4" Hose



**72R3156** RD-5-10031-0P

2" Hose, 3" O.D., 2 1/4" x 2" mounting hole



**72R3157** RD-5-8928-0P

Louver Outlet



**72R3200** RD-5-3846-0P

4 1/2" Diffuser (Flush)



**72R3510** RD-3196-1P

2 1/2" Defrost Outlet Assembly



**72R3530** RD-3196-3P

3" Defrost Outlet Assembly



**72R3550** RD-3196-5P

3 1/2" Defrost Outlet Assembly



**72R3600** RD-5-9313-0P

2 1/2" Hose



**72R3601** RD-1-0422-0P

2 1/2" Defrost Adapter



**72R3603** RD-1-0423-0P

3" Defrost Adapter

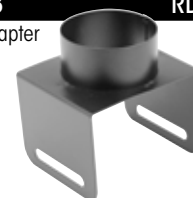

**72R4000** RD-5-9153-0P

Defrost Duct With 2 1/2" Hose Adapter  
Length = 19 3/8"  
Width = 4 3/8"  
Height = 5 1/2"



**72R4010** RD-5-9152-0P

Defrost Duct With 2 1/2" Hose Adapter  
Length = 20 1/4"  
Width = 2 1/2"  
Height = 3 3/8"



**72R4400** RD-5-9157-0P

2 1/2" Flexhose "Y" Adapter



**72R4500** RD-5-9158-0P

2 1/2" To 3" Flexhose Adapter



# 72R SERIES

## AIR DIFFUSERS, LOUVERS, DUCTS AND ADAPTERS

**72R4510** RD-5-9159-0P

2 1/2" To 2" Flexhose Adapter



**72R4530** RD-3-1566-2P

Air Outlet Assembly for 4" Hose To Square Plate



**72R4531** RD-3-4812-2P

Air Outlet Assembly for 3" Hose To Square Plate



**72R4532** RD-5-8926-0P

Straight 2 1/4" Hose Outlet



**72R4533** RD-1-0639-0P

3 1/2" Defrost Hose Outlet



RD-1-1651-0P

2 1/2" Outlet Adapter, 4-way Duct, fits R-2100



RD-2-3279-0P

Four Louver Outlet Adapter, fits R-2100

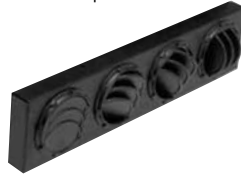

RD-3-10111-0P

Louvered Plenum Assembly, fits R-9520



RD-3-10112-0P

Ductable Plenum Assembly, fits R-9520



RD-3-6060-0P

Plenum Assembly with 2 1/2" Hose Adapters

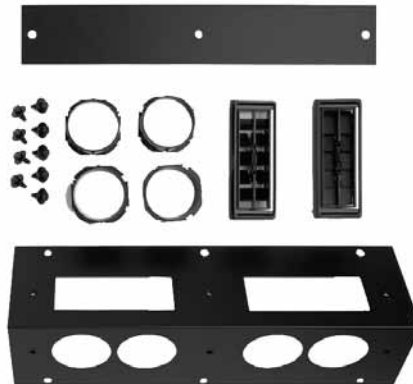

**78R2100**

RD-5-6683-0P

Universal Duct Kit

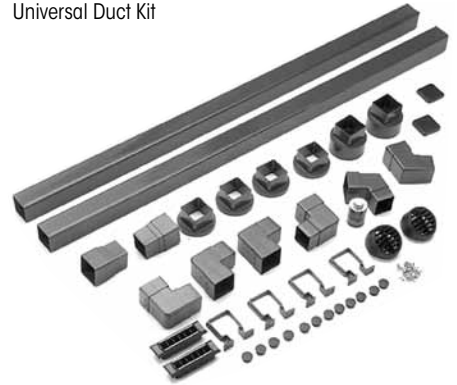

## DEFROST HOSE

**78R0200** RD-5-5122-108P

2" Defrost Hose (9 ft)

**78R0250** RD-5-5123-108P

2 1/2" Defrost Hose (9 ft)

**78R0300** RD-5-3930-108P

3" Defrost Hose (9 ft)

**78R0350** RD-4156-108P

3 1/2" Defrost Hose (9 ft)

**78R0400** RD-5-3927-108P

4" Defrost Hose (9 ft)

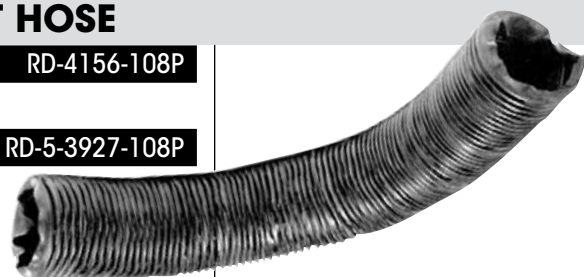

### RED DOT CABLE CONTROLLED WATER VALVES METAL

Automotive & Heavy Duty TYPE - IN LINE			FLOW	ON	OFF
<b>72R5040</b>	RD-5-4923-OP	5/8" hose to 5/8" hose	A	X	Y
<b>72R5050</b>	RD-4257-OP	5/8" hose to 5/8" hose	B	X	Y
<b>72R5055</b>	RD-5-10223-OP	5/8" hose to 5/8" hose	B	X	Y
<b>72R5060</b>	RD-5-5119-OP	5/8" hose to 5/8" hose	A	Y	X
<b>72R5070</b>	RD-5-5191-OP	3/4" hose to 3/4" hose	A	X	Y

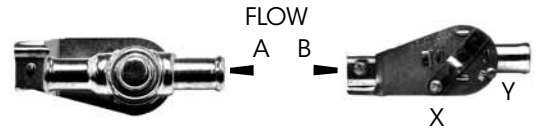

#### **72R5080** RD-5-5215-OP

5/8" Hose, 90° elbow to 5/8" Hose, 110° elbow  
Pull To Open

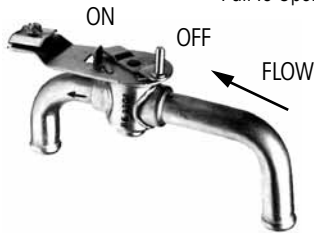

#### **72R5110** RD-5-8034-OP

5/8" Hose to 3/4" Hose  
Pull To Open



#### **72R5500** RD-5-5192-OP

5/8" Hose to 5/8" Hose  
Manual Open & Close



#### **72R5600** RD-5-5193-OP

3/4" Hose to 3/4" Hose  
Manual Open & Close



## WATER VALVES

### RED DOT CABLE CONTROLLED WATER VALVES ENGINEERED POLYMER

**72R5200**

RD-5-5300-0P

5/8" Hose to 5/8" Hose  
Pull To Close



**72R5210**

RD-5-5300-1P

5/8" Hose to 5/8" Hose  
Pull To Open



**72R5285**

RD-5-9224-1P

5/8" Hose to 5/8" Hose  
Push To Open  
Fits John Deere Wheel  
Loader 324H, 344H  
Replacement  
Cable Clip  
RD-5-8885-0M



**72R5203**

RD-3-11046-0P

3/4" Hose to 3/4" Hose with Stem Water Control Valve  
Pull To Close



Fits Caterpillar Skid Steer, B-Series, Tier II

**72R5260**

RD-5-5495-1P

5/8" Hose to 5/8" Hose  
90° Elbow\*  
Pull To Open



**72R5350**

RD-5-8193-2P

5/8" Hose to 5/8" Hose  
Pull To Open



**72R5204**

RD-5-10635-0P

5/8" Hose to 3/4" Hose with Stem Water Control Valve  
Pull To Close



Fits Caterpillar Skid Steer, A-Series, Tier I & II

**72R5270**

RD-5-5495-2P

5/8" Hose to 5/8" Hose  
90° Elbow\*  
Pull To Close



**72R5360**

RD-5-9224-0P

5/8" Hose to 5/8" Hose



All cable controlled water valves are complete with cable clamp & mounting hardware.



### RED DOT CABLE CONTROLLED WATER VALVES WITH FLOW RESTRICTER

Red Dot has designed these water valves with a flow restricter. The restricter reduces water flow to approximately 5 to 6 gallons per minute through the heater core. The benefits are easier modulation, extended water valve life and maximized heater core efficiency.

**72R5220** RD-5-7760-1P

5/8" Hose to 5/8" Hose  
Push To Open

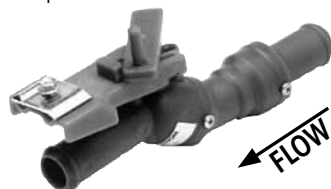

**72R5230** RD-5-7760-2P

5/8" Hose to 5/8" Hose  
Pull To Open

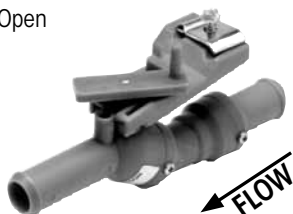

**72R5240** RD-5-7760-3P

5/8" Hose to 5/8" Hose  
Pull To Open



**72R5250** RD-5-7760-0P

5/8" Hose to 5/8" Hose  
Push To Open

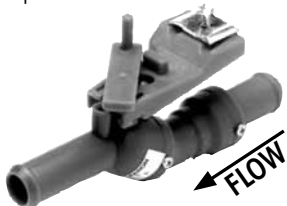

**72R5280** RD-5-8083-0P

5/8" Hose to 5/8" Hose  
Push To Open

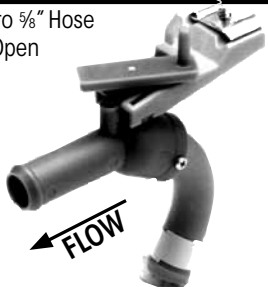

**72R5355** RD-1-2246-0P

5/8" Hose to 5/8" Hose – Water Valve & Self Clinching Pin  
Pull To Open



Fits R-9787 Model,  
AGCO Tractor 35, 45, 55 Standard & Advanced

**72R6510** RD-5-8935-0P

Pull To Open Cable Controller  
Fits Freightliner FL Series, Volvo C.O.E.



**72R6515** RD-5-8943-0P

Pull To Open Cable Controller  
Fits Freightliner FTLC120  
Century Class 1996-2002  
OE#A22-44-553-000



**72R6520** RD-5-10344-0P

5/8" Hose To 5/8" Hose  
Pull to Close  
Fits Freightliner Applications

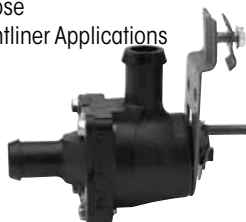

**72R6525** RD-5-8390-0P

Water Valve for Caterpillar Motor Grader 24H



**72R6530** RD-5-10345-0P

5/8" Hose To Core Mount – Pull to Close  
Fits Freightliner and Volvo Applications



**72R6533** RD-5-11319-0P

5/8" Hose To Core Mount – Pull to Open  
Fits Freightliner and Volvo Applications  
Volvo OE#1118414, 176362



**72R6535** RD-5-8894-0P

5/8" Hose To Core Mount – Pull to Open  
Fits Caterpillar Long / Large Haul 793, 797

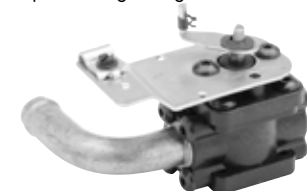

**72R6540** RD-5-9415-0P

Red Dot Model R-6120 Gillig Bus, R-6135 Orion Bus  
Gillig Models 21-43550, 21-55565  
Orion Models 071320036, 058, 151  
5/8" x 5/8" hose  
Cable controlled  
Pull to Open



**72R6547** RD-5-10055-0P

5/8" Hose To Core Mount – Pull to Close  
Fits Caterpillar Small Track Tractor  
(STTT Series)  
D3, D4, D5

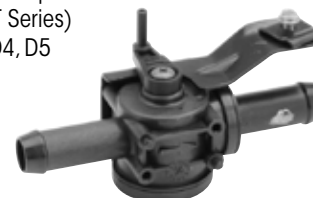

## WATER VALVES

### RED DOT AIR OPERATED WATER VALVES

**72R6400**

RD-5-8804-0P

½" Hose To ½" Hose



**72R6401**

RD-5-8804-1P

½" Hose To ½" Hose



**72R6403**

RD-5-8804-2P

½" Hose To ½" Hose



**72R6410**

RD-5-8859-0P

¾" Hose To ¾" Hose



**72R6420**

RD-5-8857-0P

¾" Hose To ¾" Hose



**72R6421**

RD-5-8857-1P

¾" Hose To ¾" Hose



**72R6423**

RD-5-8857-2P

¾" Hose To ¾" Hose



**72R6425**

RD-5-8857-3P

¾" Hose To ¾" Hose



**70R8420**

RD-5-4497-0P

Female fitting for air operated water valves on this page



**LS** = Limited to stock on hand

**NOTE:** Air operated water valves require 80 to 120 PSI of air to operate. Air supply threads are ½"-27 NPT.

**ELECTRONIC WATER VALVE**

**72R7100**

RD-5-10258-0P

12 or 24 Volt 3/8" hose connections  
Replacement knob available separately: 71R4063



**72R7105**

RD-5-8135-0P

Replacement  
Electronic Water Valve



## WATER VALVES CONTROL CABLES

### CONTROL CABLES

Part No.	Factory No.	Description	End 1	End 2
<b>72R7280</b>	RD-4124-18P	18" with knob	C	B
<b>72R7290</b>	RD-4124-20P	20" with knob	C	B
<b>72R7600</b>	RD-4124-38P	38" with knob	C	B
<b>72R7700</b>	RD-4124-76P	76" with knob	C	B
<b>72R8190</b>	RD-4180-24P	24"	A	C
<b>72R8200</b>	RD-4180-29P	29"	A	C
<b>72R8250</b>	RD-4180-36P	36"	A	C
<b>72R8255</b>	RD-5-9225-36P	36"	C	C
<b>72R8270</b>	RD-5-6802-0P	41"	C	C
<b>72R8280</b>	RD-5-6803-0P	44"	C	C
<b>72R8300</b>	RD-4180-46P	46"	A	C
<b>72R8315</b>	RD-5-6667-46P	46"	C	C
<b>72R8360</b>	RD-4180-57P	57"	A	C
	RD-3-9188-0P	65 1/2"	A	B
<b>72R8400</b>	RD-4180-76P	76"	A	C
<b>72R8410</b>	RD-4180-79P	79"	A	C

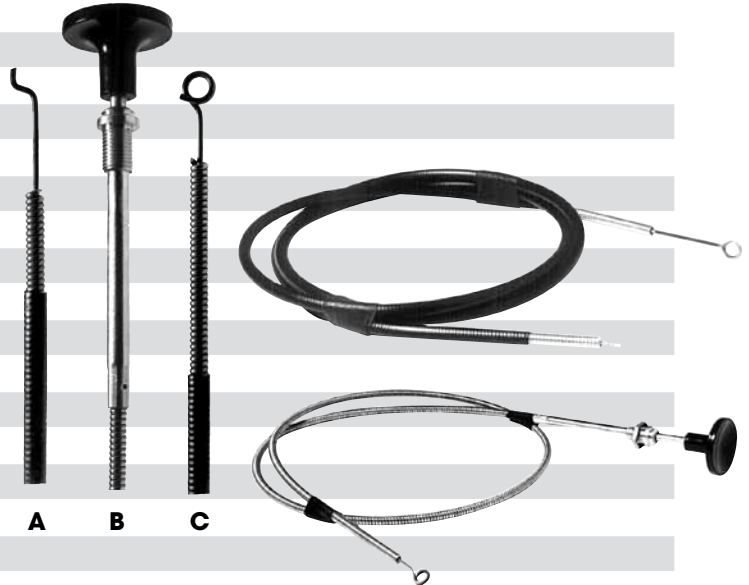

### 72R9000

RD-5-7999-0P

Shown With Knob 71R4020 — Use With Cable Ends "A" & "C"  
Replacement Hot/Cool Label RD-5-8886-0M

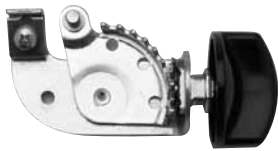

### 72R9005

RD-5-6917-2P

Converter Control  
and Cable  
28 3/4" long

Recommended knob:  
71R4040

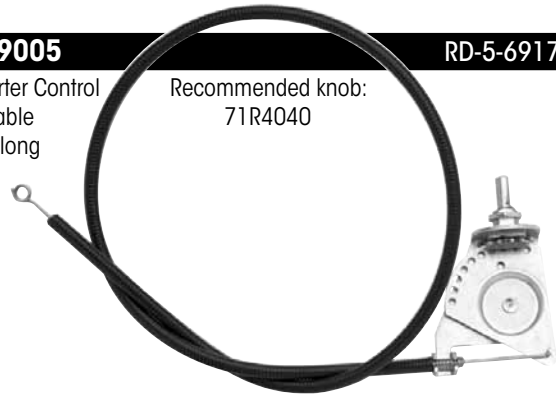

### CABLE CONVERTER ASSEMBLIES



<b>72R8260</b>	RD-5-9443-2P	24 1/16"	C
<b>72R8265</b>	RD-5-9443-3P	27 1/4"	C
<b>72R8275</b>	RD-5-9443-4P	83 1/4"	C